

MUD SUCKER®
DIAPHRAGM PUMPS

2FAC-DD™
Series

DOUBLE
DIAPHRAGM
PUMPS

- Air
- Electric
- Gas
- Diesel
- Hydraulic

FEATURES

1.5" or 2" Connection size

Pump up to 40 GPM

Transfer spherical solids up to 1 1/4" or 50% by volume

Pump up to 50' vertical or 300' horizontal

7" heavy duty diaphragm

Multiple drive options and industry specific components

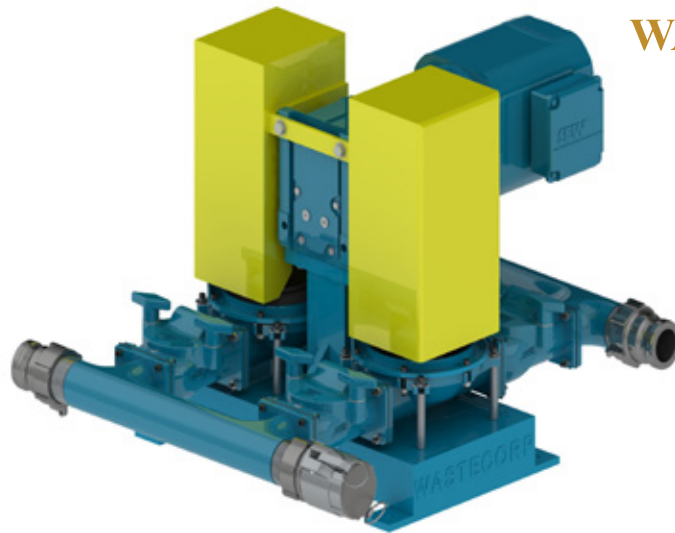

IT'S WHAT'S INSIDE THAT COUNTS.
The New Mud Sucker® 2" Double Diaphragm Series

The Mud Sucker® 2FAC-DD™ Series is a double diaphragm pump engineered for dewatering, dredging, waste oil transfer and most multipurpose applications up to 40 GPM. You have a choice of single or three phase electric gas or diesel, hydraulic or pneumatic drive systems. Not to be confused with air operated double diaphragm pumps (AODD), Mud Sucker pumps uses next generation mechanical double diaphragm pump technology. You also have a choice between 2" and 1.5" connection sizes.

Performance Range

Max. capacity	40 GPM
Max. Suction lift	20' vertical or 75' horizontal
Max. discharge head	50' vertical or 300' horizontal
Solids handling	1.5" dia or 50% by volume

Pump Specifications

Suction inlet/outlet size	1.5" or 2"
Max. liquid temperature	140°F continuous
Pump castings	Aluminum A356, heat treated
Diaphragm	7" dia blended rubber / fabric reinforced
Flapper valves	EPDM
Gaskets	Neo-nylon
Bearing	Cam follower
Crank arm	AISI 12L14 Carbon Steel
Hardware	Zinc coated
Lubrication	Alemite grease fitting
Gear reducer	Constant speed (SEW or Siemens)

Electric Motor Specifications

Description	Part No.	Motor Option
Standard three-phase motor (TEFC)	64723-10	2HP; 1800RPM
Single Phase (TEFC)	64723-00	2HP; 1800RPM
Explosion Proof (Three phase, TEXP)	64723-30	2HP; 1800RPM
Explosion Proof (Single phase), TEXP	64723-20	2HP; 1800RPM

Engine Motor Specifications

Honda Gas	64814-00	5 HP Honda
Diesel	64814-10	4.6 HP; Hatz

Pneumatic Motor Specifications

Pneumatic motor	64812-00	2.4HP; 75CFM, 1800 RPM, 80 PSI air operated
-----------------	----------	---

Hydraulic Motor Specifications

Hydraulic motor	64813-00	2HP@1800RPM (500PSI)
-----------------	----------	----------------------

Mud Sucker® Double Diaphragm Pumps

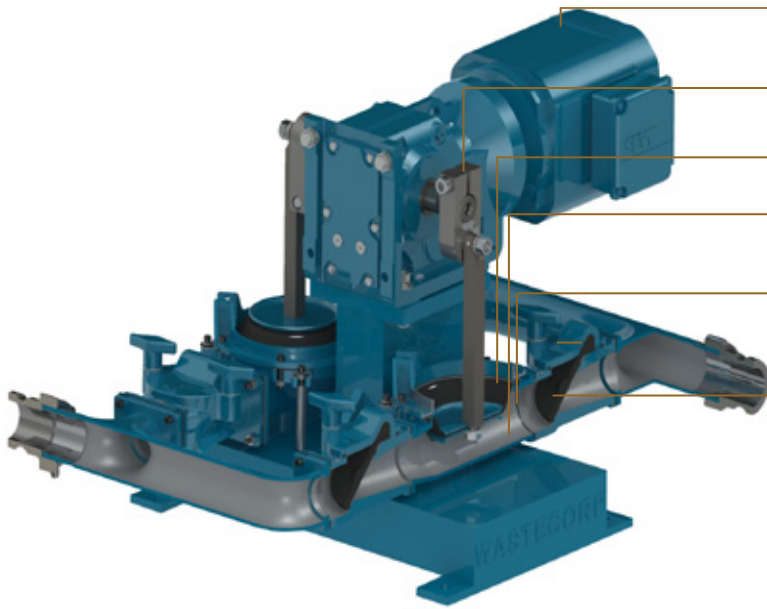

Select from five drive systems including air, hydraulic, electric, gas or diesel.

Premium crank arm to pump the tough stuff

Durable 7" blended rubber diaphragm

Exclusive Wastecorp engineered velocity channel to move fluids without clogging

Pump Internals available with industry specific coating options (corrosion, abrasion resistance)

Severe duty EPDM flapper system. Access suction and discharge in seconds with the twist of a handle.

Standard enclosure (removed for clarity) surrounds moving components

Mud Sucker compact double diaphragm pumps are manufactured in North America. Country/region specific models are available worldwide.

Mud Sucker® 2FA-DD Series Dimensional Drawing

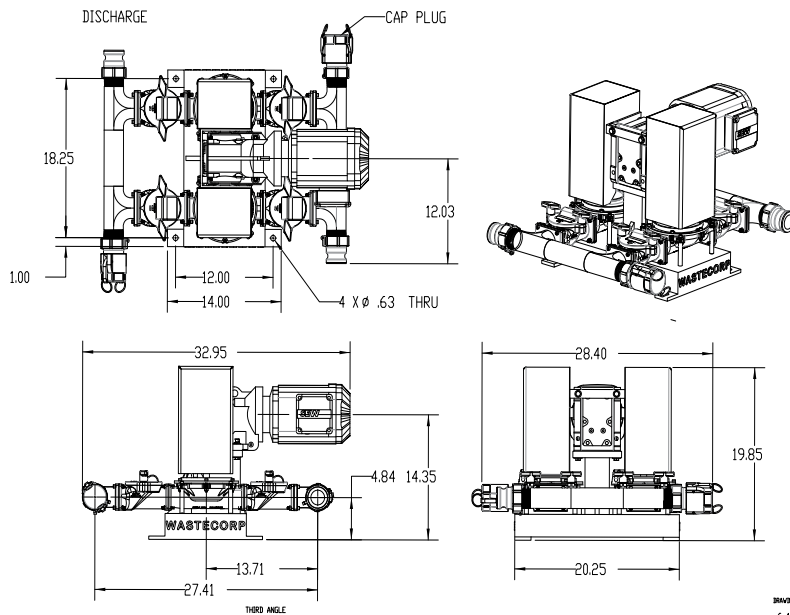

Performance Curve

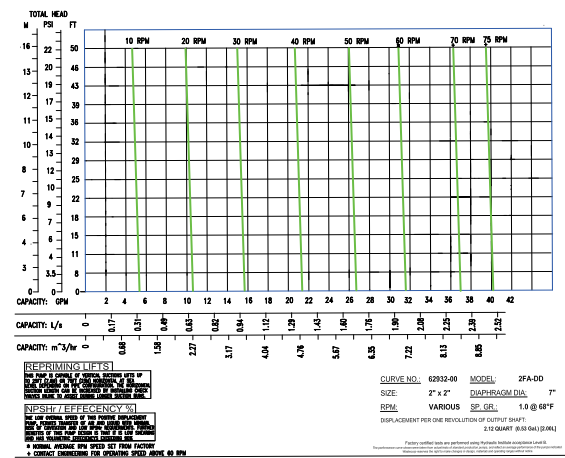

DRAWING NUMBER
54723-00

Drive Options

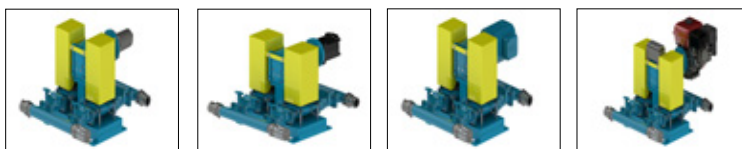

















Air

Hydraulic

Electric

Engine

ACCESSORIES

Part no.	Description	Part no.	Description
 19022-00	Recommended! Pressure relief valve, bronze set at 40 psi	 60891-00	Wagon kit 24" W
 61285-10	Basic spare parts kit (diaphragm and flappers)	 60506-00	The Gulper™ Suction tool No more bending
 61285-12	VITON® MATERIAL Basic spare parts kit (diaphragm and flappers)	 60536-00	Clear swing check valve 2" FPTxFPT
 61284-10	Comprehensive spare parts kit (diaphragm, flappers gaskets, weights and hardware)	 62742-00	Air chamber assembly. Pulsation dampening
 61284-12	VITON® MATERIAL Comprehensive spare parts kit (diaphragm, flappers gaskets, weights and hardware)	 Various	Wet section coatings for specific applications
 60718-00	Non-collapsible EPDM hose 2"x20'. Camlocks included	 62302-00	SEW Movimot 24V key pad speed control
 51333-10	Discharge hose, lay flat (brown) 2"x50'. Camlocks included	 61492-00	Starter Control Panel w/ NEMA 12 protection
 34383-00	Stainer, sq. hole (solids) 2" FNPT	 61491-00	Transformer start/estop, w/ Nema 12 overload protection

Mud Sucker® Diaphragm Pumps

Toll-Free: 1.888.829.2783 Email: info@wastecorp.com

WASTECORP
Pumps®
OEM Manufacturer

Wastecorp's Mud Sucker small double diaphragm pump series are ideal for marine, general wastewater and industrial process applications. Mention your application to your technical support representative at the time of order. Before operating your diaphragm pump, read, understand and follow all instructions in the manual and on the pump. Specifications and programs are accurate at the time of publication but subject to change without notice. Images may not reflect dealer inventory and/or unit specifications. Wastecorp, Mud Sucker and globes are registered trademarks of Wastecorp, WPI. No reproduction of this document without permission. © Wastecorp 2019 V1.