

MUD SUCKER®
DIAPHRAGM PUMPS

DD-M™ Series

Engine Driven
DOUBLE
DIAPHRAGM
PUMPS

3FA-MDD™

FEATURES

Pump up to 160 GPM

Transfer solids up to 2¼" or
50% by volume

Aluminum pump body

13" diaphragms (x2)

High performance fabric rein-
forced Viton® flapper valves



WASTECORP.
Pumps®

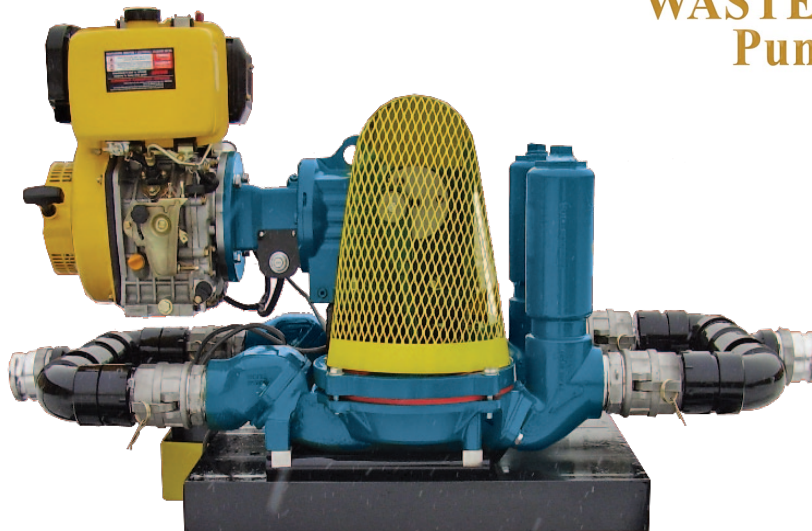

PUT MORE "JUICE" INTO YOUR PUMPING OPERATION. POWERFUL 3FA-MDD SERIES PUMPS

For double diaphragm pumping power outdoors, the Mud Sucker® engine driven (flapper valve) series is a favorite among concentrated juice producers, wineries, producers of soy based products, aquaculture operations and fruit and vegetable companies. This series is also ideal for transferring grain residues common in the brewery process and at dairy farms. With 3" connections and 13" diaphragms you can transfer up to 160 GPM and pump solids up to 2¼".

Double Diaphragm Pumps Designed for The Long Haul

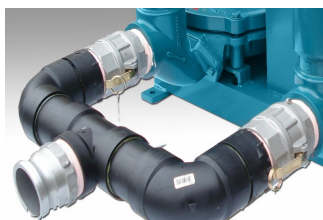
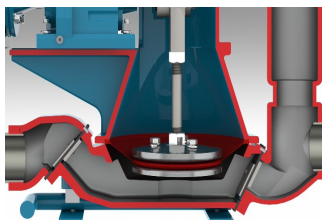

SMARTER PUMP DESIGN

Like all FA Series pumps the industry exclusive contoured velocity channel makes pumping easier, more efficient and consistent

PIPING DESIGNED FOR YOUR PUMP SPACE

Don't settle for someone else's piping design. Get the piping configuration that help you pump more volume, more efficiently.

TOP RATED PUMP DRIVE SYSTEMS

Top rated drive systems available in gas or diesel.

WHAT THIS MEANS TO YOU.

Less clogs and more power means you spend less time monitoring your fluid handling application.

The piping arrangement is designed based on your type of fluid and pump house arrangement.

Enhanced performance with motors designed for your pump helps you take advantage of all the Mud Sucker pump can do for you

MUD SUCKER® DIAPHRAGM PUMPS THE PUMP WITH ATTITUDE.

wastecorp.com

Meet The Mud Sucker Double Diaphragm Pump Series

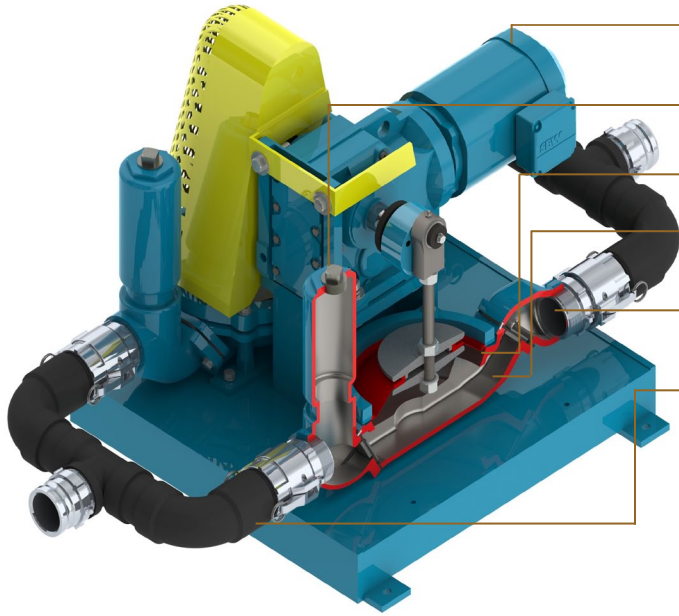

- Powered by Yanmar®, Kohler® Honda® or equivalent gas/diesel engines.
- Pulsation dampening air chambers
- 13" Santoprene® diaphragm
- Exclusive Wastecorp engineered velocity channel to move fluids without clogging
- Pump Internals available with industry specific components
- Select from five piping configurations (single suction, single discharge shown)

Manufactured in North America. Country/region specific models are available worldwide.

Performance Range

Max. capacity	160 GPM
Max. Suction lift	25' vertical or 75' horizontal
Max. discharge head	50' vertical or 300' horizontal
Solids handling	2.250" dia or 50% by volume

Pump Specifications

Suction inlet/outlet size	3"x3"
Max. liquid temperature	220°F (104°C) continuous
Pump body casing	Marine grade aluminum (ASTM A356, Class 30)
Diaphragm	13" dia TPE Santoprene® Severe duty
Flapper valves	Fabric reinforced Buna-N (viton optional)
Gearbox	SEW Eurodrive Model R77 cast iron housing with heat treated gears
Hardware	Zinc coated
Rod end bearing body	Cast iron, sealer coating for corrosion resistance
Ball bearing	Cast iron, sealer coating for corrosion resistance
Ultimate radial static load capacity	9,000 Lbs

Motor Specifications

Description	Part No.	Motor Option
Gas/petrol engine	61763-00	9 hp gas Honda GX 270
Diesel engine	61763-10	9 hp diesel Kohler/Yanmar

Double Diaphragm Pump Dimensional Drawing

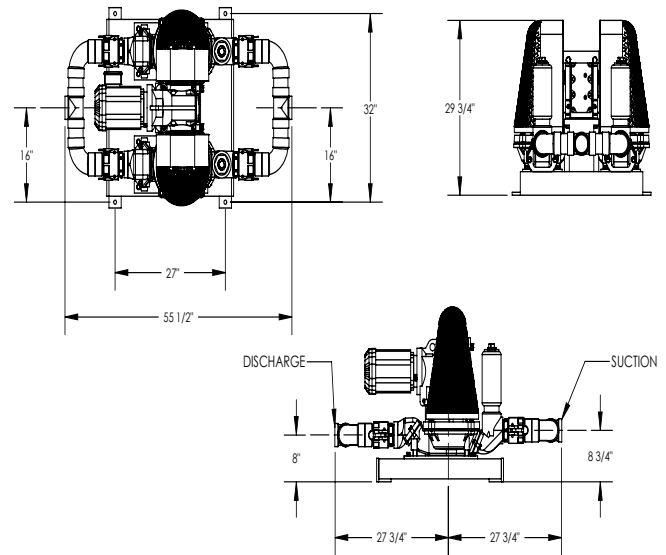

Performance Curve

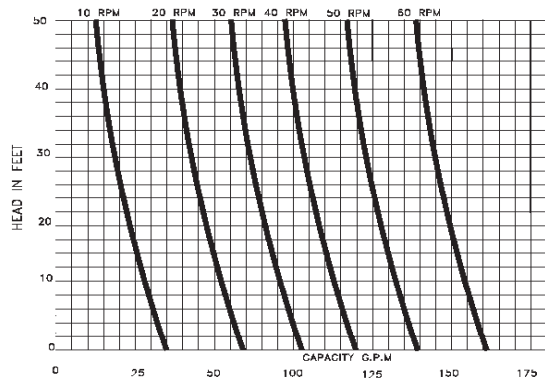

Pump Piping Options

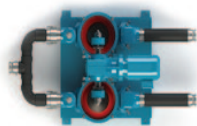

Single suction with double outlet

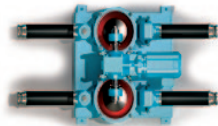

Double suction with double outlet

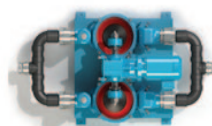

Single suction with single outlet

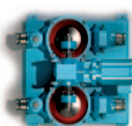



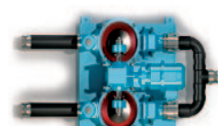







Standard Design



Double suction with single outlet



ACCESSORIES

Part no.	Description	Part no.	Description
 19022-00	Recommended! Pressure relief valve, bronze set at 40 psi	 61292-00	Wheel mount kit (specify atv, tractor or manual tow package)
 63198-00 63198-10	Basic spare parts kit (diaphragm and flappers) Viton use 62198-10	 60466-00	Camlock fitting 3" alum. male adapter MNPT
 63199-00 63199-10	Comprehensive spare parts kit (diaphragm, flappers gaskets, weights and hardware). Viton use 62198-10	 63200-00	Air chamber assembly for pulsation dampening
 60723-00	Non-collapsible EPDM hose 3"x20'. Camlocks included	 Various	Wet section coatings for specific applications
 51334-10	Discharge hose, lay flat (brown) 3"x50'. Camlocks included	 61245-00	Clear swing check valve 3" FPTxFPT

Mud Sucker® Diaphragm Pumps

Toll-Free: 1.888.829.2783 Email: info@wastecorp.com

WASTECORP.
Pumps®
OEM Manufacturer

Mud Sucker double diaphragm pumps are specified for coal slurry, septic system pumping, breweries, dairy farms, dewatering, food processing, FDA compliant pumping systems and most multipurpose pumping applications. Mention your application to your technical support representative at the time of order. Before operating your diaphragm pump, read, understand and follow all instructions in the manual and on the pump. Specifications and programs are accurate at the time of publication but subject to change without notice. Images may not reflect dealer inventory and/or unit specifications. Wastecorp, Mud Sucker and globes are trademarks of Wastecorp, WPCI Environmental Brands. No reproduction of this document without permission. © Wastecorp.