

**Mud Sucker®  
Diaphragm Pumps**

**B Series**

**Solids Crushing  
Diaphragm Pumps**

4B-EC™

Standard Piping

3B-EC™

In-line Piping



**Performance Range**

<b>Max. capacity</b>	110 GPM
<b>Max. suction lift</b>	25' vertical or 75' horizontal
<b>Max. discharge head</b>	50' vertical or 300' horizontal
<b>Solids handling</b>	2¼" dia or 50% by volume

**Pump and Motor Specifications**

<b>Suction inlet/outlet size</b>	4"x4"
<b>Max. liquid temperature</b>	104°F (40°C) continuous
<b>Pump body casing</b>	Cast iron (ASTM A356, Class 30)
<b>Diaphragm</b>	14¾" dia thermoplastic elastomer (red) Severe duty -25°F to 212°F Optional: Neoprene
<b>Ball valves</b>	5-1/8" diameter polyurethane with steel core
<b>Gearbox</b>	Helical bevel cast iron housing with heat treated gears
<b>Hardware</b>	Zinc plated
<b>Rod end bearing body</b>	Cast iron, protective coated for corrosion resistance
<b>Ball bearing</b>	Cast iron, protective coating for corrosion resistance
<b>Ultimate radial static load capacity</b>	9,000 Lbs

**Motor Options**

<b>Description</b>	<b>Part No.</b>	<b>Motor Option</b>
Standard motor (TEFC)	61737-00	5 hp, 1800RPM/3/60/230-460V
Single phase (TEFC)	61737-10	5 hp, 1800RPM/1/60/230V
Explosion proof (three phase, TEXP)	61737-20	5 hp, 1800RPM/3/60/230-460V
Explosion proof (single phase, TEXP)	61737-30	3 hp, 1800RPM/1/60/115-230V

**FEATURES**

- 4" Connection size
- Pump up to 110 GPM
- Transfer spherical solids up to 2 1/4" or 50% by volume
- Pump up to 50' vertical or 300' horizontal
- 143/4" heavy duty diaphragm
- Multiple drive options and industry specific components.

**PROFESSIONAL**

Mud Sucker® Diaphragm Pumps  
**4B Series**

Professional Solids Handling Diaphragm Pumps

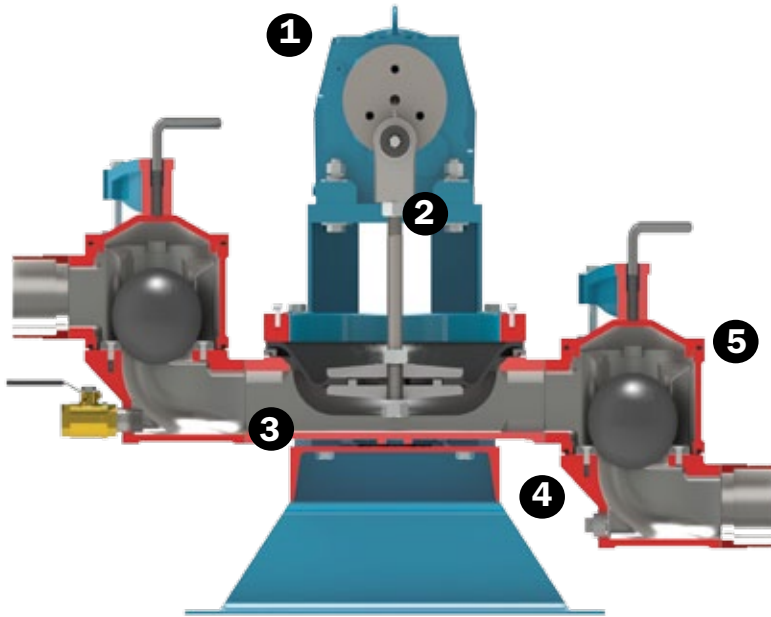

- 1** Premium drive systems form the industry's top rated manufacturers.
- 2** Heavy duty crank arm designed to pump the tough stuff at 110 GPM (max).
- 3** Exclusive Wastecorp engineered contoured velocity channel to move fluids without clogging.
- 4** Heavy duty cast iron pump body for unmatched durability.
- 5** Valve chambers crush solids or make slurries easier to pump. crushing performance.

..... Professional Options for Professional Applications .....



Wastewater Containment System



4B Series - Trolley Mounted



4B Series - Trailer Mounted



Wastewater Containment System

4B Series - Trolley Mounted



4B Series - Trailer Mounted

**Mud Sucker® Diaphragm Pumps**

Toll-Free North America  
 1.888.829.2783

Worldwide  
 201.445.2882

Website  
<http://www.wastecorp.com>



















E-mail  
[info@wastecorp.com](mailto:info@wastecorp.com)



Mud Sucker B Series pumps are designed and specified to pump landfill leachate, agricultural waste, select manure pumping applications, mining waste, bauxite waste pumping, waste oil, biodiesel applications, coal slurry, tar sands applications, aquaculture, industrial fluids and more. Consult factory with flow rates and percentage of solids you are pumping before ordering. © Wastecorp, no reproduction without authorization



# ACCESSORIES

Part no.	Description	Part no.	Description
	19022-00 <b>Recommended!</b> Pressure relief valve, bronze set at 40 psi		61315-00 Wheel mount kit with handles
	63166-00 Basic spare parts kit (diaphragm and flappers)		63165-00 Comprehensive spare parts kit (diaphragm, flappers gaskets, weights and hardware)
	60718-00 Non-collapsible EPDM hose 2"x20'. Camlocks included		Various Wet section coatings for specific applications
	51333-10 Discharge hose, lay flat (brown) 2"x50'. Camlocks included		62304-00 SEW Movimot 24V key pad speed control
	34383-00 Stainer, sq. hole (solids) 2" FNPT		61492-00 Starter Control Panel w/ NEMA 12 protection
	61387-00 Universal sewer adapter assembly		61491-00 Transformer start/estop, w/ Nema 12 overload protection
	60536-00 Clear swing check valve 2" FPTxFPT		62974-00 3-way brass valve w/ aluminum camlocks
	60270-00 Camlock fitting 3" alum. male adapter MNPT		60506-00 The Gulper™ Suction tool No more bending
	61813-00 Gauge, 0-160 PSI (air models only)		61755-00 3-pc combo/regulator/lubricator/filter/ mounting bracket (air models only)
No image available	62534-00 Ball valve 1/4" FNPT (air models only)		