

Mud Sucker®
Diaphragm Pumps

B Series

Solids Crushing
Diaphragm Pumps

- 4B-M™
- Standard Piping
- Engine Driven

FEATURES

- 4" Connection size
-
- Pump up to 110 GPM
-
- Transfer spherical solids up to 2¼" or 50% by volume
-
- Pump up to 50' vertical or 300' horizontal
-
- 14¾" heavy duty diaphragm
-
- Multiple drive options and industry specific components



WASTECORP.
Pumps®

PROFESSIONAL

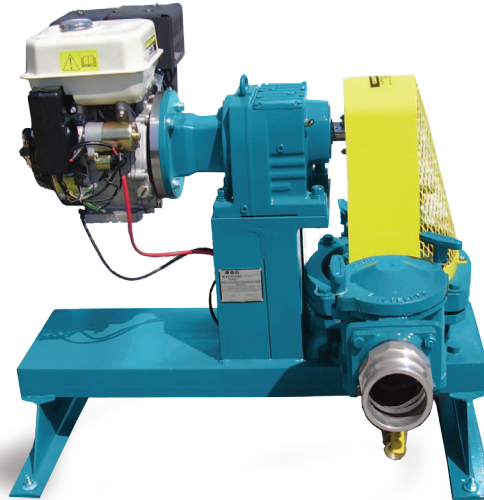

Performance Range

Max. capacity	110 GPM
Max. suction lift	25' vertical or 75' horizontal
Max. discharge head	50' vertical or 300' horizontal
Solids handling	2¼" dia or 50% by volume

Pump and Motor Specifications

Suction inlet/outlet size	4"x4"
Max. liquid temperature	104°F (40°C) continuous
Pump body casing	Cast iron (ASTM A356, Class 30)
Diaphragm	14¾" dia thermoplastic elastomer (red) Severe duty -25°F to 212°F Optional: Neoprene
Ball valves	5-1/8" diameter polyurethane with steel core
Gearbox	Helical bevel cast iron housing with heat treated gears
Hardware	Zinc plated
Rod end bearing body	Cast iron, protective coated for corrosion resistance
Ball bearing	Cast iron, protective coating for corrosion resistance
Ultimate radial static load capacity	9,000 Lbs

Motor Options

Description	Part No.	Motor Option
Gas Engine	61727-00	9 hp, Honda GX270
Diesel Engine	61727-10	6.5 hp, Kohler/Yanmar

PROFESSIONAL

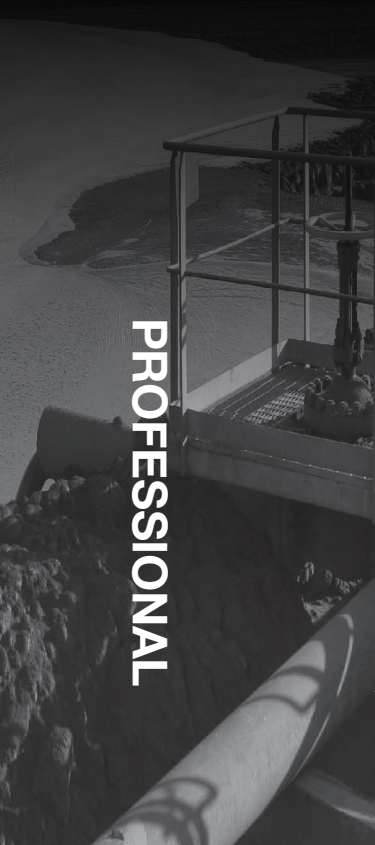

Mud Sucker® Diaphragm Pumps 4B Series

Professional Solids Handling Diaphragm Pumps

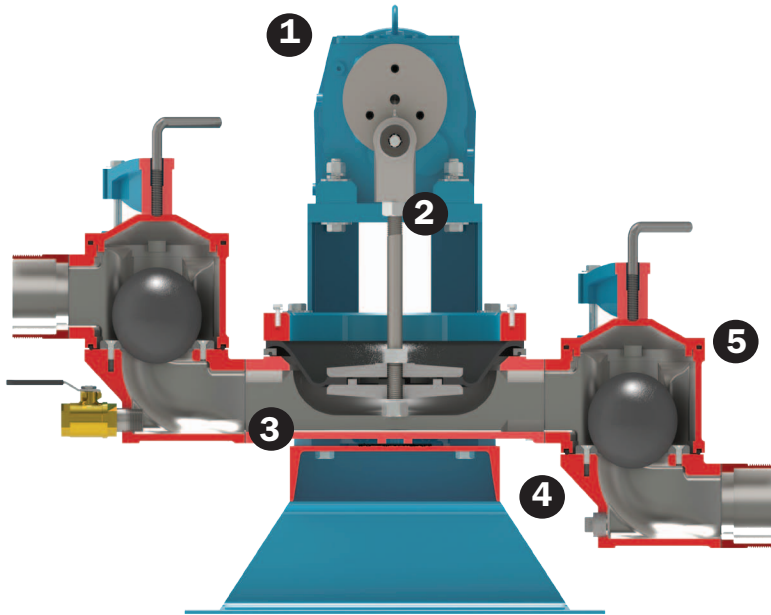

- 1 Premium drive systems form the industry's top rated manufacturers.
- 2 Heavy duty crank arm designed to pump the tough stuff at 110 GPM (max).
- 3 Exclusive Wastecorp engineered contoured velocity channel to move fluids without clogging.
- 4 Heavy duty cast iron pump body for unmatched durability.
- 5 Valve chambers crush solids and make slurries easier to pump.

Professional Options for Professional Applications



Wastewater Containment System



4B Series - Trolley Mounted



4B Series - Trailer Mounted



4B Series - Dolly Mounted



4B Series - In-line Configuration

Mud Sucker® Diaphragm Pumps

Toll-Free North America
1.888.829.2783

Worldwide
201.445.2882













Website
<http://www.wastecorp.com>

E-mail
info@wastecorp.com

WASTECORP.
Pumps®
OEM Manufacturer



ACCESSORIES

Part no.	Description	Part no.	Description
 19022-00	Recommended! Pressure relief valve, bronze set at 40 psi	 61747-00	Utility trailer (non-DOT) w/2" ball hitch
 61740-00	Basic spare parts kit (diaphragm and flappers)	 61741-00	Comprehensive spare parts kit (diaphragm, flappers gaskets, weights and hardware)
 60728-00	Non-collapsible EPDM hose 2"x20'. Camlocks included	 Various	Wet section coatings for specific applications
 51333-10	Discharge hose, lay flat (brown) 2"x50'. Camlocks included	 60469-00	Camlock fitting 4" alum. male adapter MNPT
 34383-00	Stainer, sq. hole (solids) 2" FNPT	 60506-00	The Gulper™ Suction tool No more bending
 61387-00	Universal sewer adapter assembly	 61537-00	Clear swing check valve 4" FPTxFPT